

# The Ribbon Hand Dryer

TSL.R.030

With an acoustically insulated and powerful blower unit, the Ribbon Hand Dryer offers a quiet user experience with fast and efficient drying times. Furthermore, with a touch free sink mounted system, there are no longer any drips carried across your washroom floors.

Finish	Codes
● Black	TSL.R.030.BK
● Brass	TSL.R.030.BR
● Satin	TSL.R.030.CS
● Copper	TSL.R.030.CP
● Chrome	TSL.R.030.C
● Bronze	TSL.R.030.BZ



+ Satin

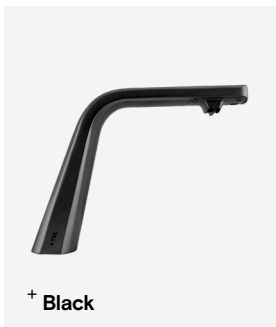

+ Black

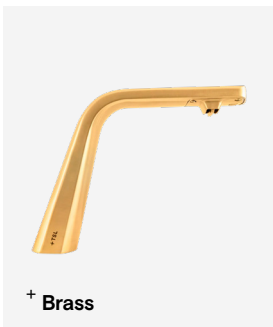

+ Brass

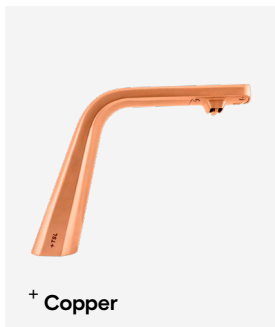

+ Copper

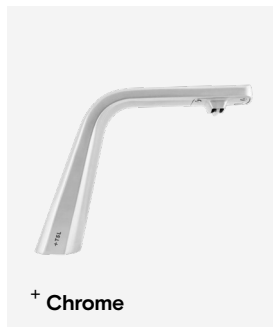

+ Chrome

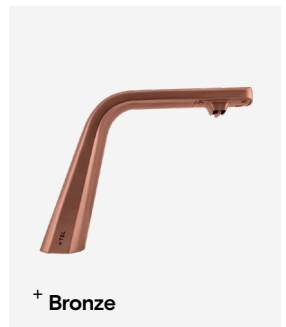

+ Bronze

## Technical Data

Voltage	110 - 120 ac; 50/ 60 Hz
Current draw	7.6-8.4A
Power consumption	0.84-1.0kW
Standby power	0.3- 0.4W
Drying time	<15 seconds
Weight	17lb 13oz
Material	AISI 304 stainless steel
Noise levels	70.6dB
Heating element	500W
Motor type	Brush type; dual ball bearings
Motor power	500-350W
Air speed	367 ft/s
Air flow	25.3 cu ft/min
Sensor range	5 " +/- 1"
Security cut-off time	60 seconds
Motor thermal protection	Auto resetting thermostat set at 203° F
Heater thermal protection	Auto resetting thermostat set at 185° F Thermal cutout fuse set to 288° F
Insulation	Class 1
IP rating	IP35
Approvals	CE, UL, cUL, RoHS, ADA
Filter	3M filter assembly (HEPA filter is available for this product, please enquire for technical information)

## Installation Requirements

Counter-top cut-out (dia)	1 3/8" diameter
Maximum countertop thickness	1 3/8"
Anti-rotation collar	Included
Reflective surfaces	Not to be installed above highly polished basins
Access requirements	Motor to be accessible at all times for servicing
Cabling	15A fused branch circuit is required
Power supply	Power supply It is recommended that the sensors are installed on their own circuit to avoid interference from other power demands. (i.e lighting)

## Compliance & Certificates

CE

UL

cUL

RoHS

ADA

### Included

- The Ribbon Dryer
- Dryer head assembly
- Hand dryer motor unit
- Power cable
- Anti-rotation collar (already installed)
- Gasket (already installed)
- Anti-rotation washer
- Fixing nut
- Motor mounting screws
- Hex wrench
- Air hose

### Not Included

- HEPA filter
- Sink
- A 15A fused supply (must be provided prior to installation)

### + Technical Drawing

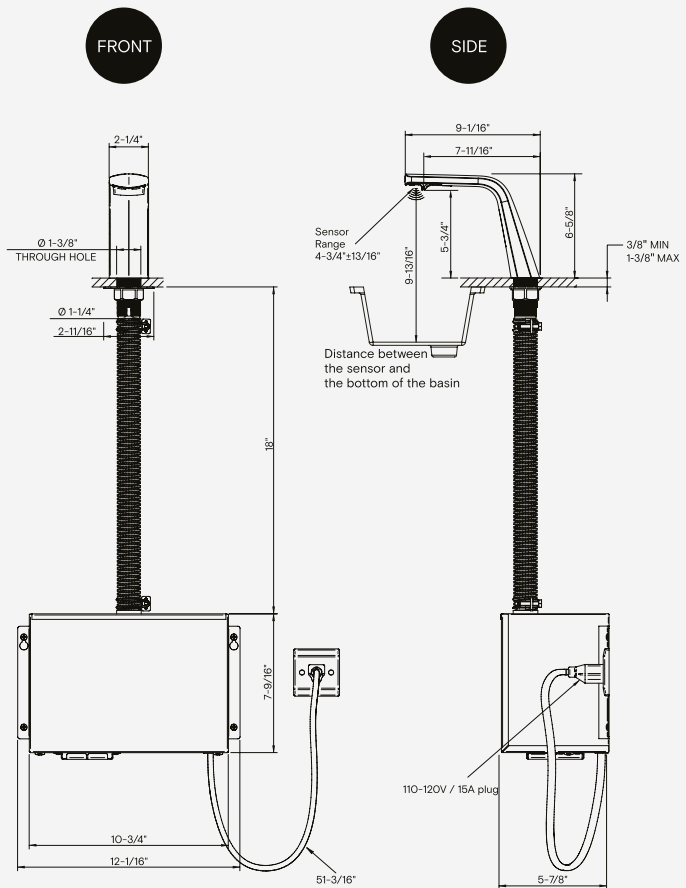

### Warranty & Replacement Parts

TSL backs every fixture with a lifetime guarantee against material defect.

For warranty terms and conditions please visit [www.thesplashlab.com/usa/warranty](http://www.thesplashlab.com/usa/warranty)

For replacement parts, please contact The Splash Lab at [info.usa@thesplashlab.com](mailto:info.usa@thesplashlab.com) for further information.

Part	Codes
IR Sensor for Ribbon Dryer	L120120

### Related Products



**The Ribbon Soap Dispenser**  
TSL.R.O10



**The Ribbon Faucet**  
TSL.R.O20

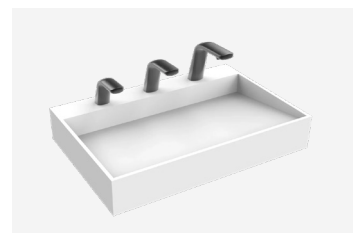

**The Ribbon Sink**  
TSL.NANOR